

# Orkot<sup>®</sup> Marine Bearings

## ENGINEERING MANUAL

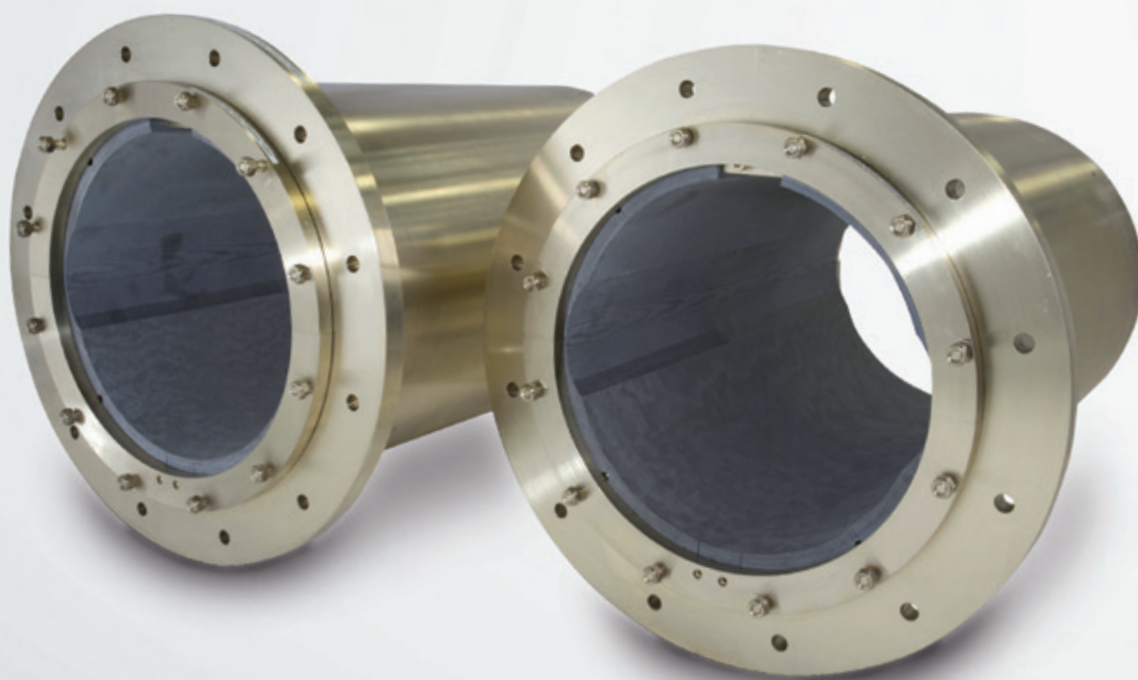

---

## ■ Contents

---

<b>03</b>	<b>General</b>
03	Introduction
03	Material description
03	Manufacturing
03	Management systems and classification

---

<b>04</b>	<b>Properties / Specifications</b>
04	Material Datasheet- Metric
05	Material Datasheet- Inch
06	Service and Support
06	Website
06	Worldwide Availability
07	Marine Stock Tube Sizes
08	Marine Stock Sheet Sizes
08	Standard Production Capacity Guidelines

---

<b>09</b>	<b>Rudder Bearings</b>
09	Bearing and Design Pressure
09	Material Selection
09	Lubrication
09	Housing and Shaft Requirements
10	Design
11	Machining Tolerance

---

---

<b>12</b>	<b>Water-Lubricated SternTube Bearings</b>
12	Bearing and Design Pressure
12	Material Selection
12	Shaft Requirements
12	Design
14	Machining Tolerance

---

<b>15</b>	<b>Installation</b>
15	Fitting Methods (Freezing, Pressing, Bonding and Mechanical)
18	Machining Instructions
20	Health and Safety Data
24	Calculation Sheet

---

<b>25</b>	<b>Contacts</b>
-----------	-----------------

---

## ■ General

### ■ Introduction

Orkot® is the brand name of a range of proprietary composite bearing materials consisting of a matrix of fabric-reinforced polymers from Trelleborg Sealing Solutions. Orkot® is exclusively manufactured in three locations: United Kingdom, United States and China.

For over 60 years Orkot® bearings have been used in industrial, offshore, oil & gas and shipbuilding applications. Orkot® TLMM and TXMM bearing materials carry approval by classification societies worldwide. Many applications, such as steering and propulsion of merchant and navy ships, involve safety critical parts.

Orkot® Marine Bearings are manufactured from a unique synthetic composite incorporating solid lubricants for dry running to ensure outstanding wear life. Virtually no swelling in sea water and very low thermal coefficient of expansion provide dimensional stability in either arctic and tropical seas. They do not corrode or promote corrosion of the housing. Orkot® bearings can be designed to tolerate edge loading and misalignment. Orkot® TXMM has been tested in independent test installations, including the U.S. Army Corps of Engineers, and is approved for use in marine applications.

Extensive experience has been gained within the shipbuilding and offshore industries with a wide range of applications on board both merchant and military vessels.

### ■ Material description

Orkot® thermosetting materials, at the molecular level, incorporate long chains of chemically cross-linked polymer molecules in a dense, 3D network. This cross-linked network ensures the integrity of the solid material. Once the polymer has become solid (cured) it possesses a high mechanical and chemical stability. Unlike in thermoplastic polymers, the solidifying process in Orkot® materials is irreversible. The polymer does not exhibit a melting point at high temperature, nor does it have a glass transition point at low temperature. There is no risk of brittleness or chatter when used in extremely cold, even cryogenic conditions.



### ■ Manufacturing

The fabric and reinforced polymer matrix are processed into either tubes or flat sheets. After subsequent curing, the result is a product with a laminated structure, designed to withstand extremely high pressure perpendicular to the laminate.

The polymer matrix is reinforced by a woven fabric made of synthetic fibers. Organic fibers, such as cotton, are not used due to their tendency to swell in water.

To obtain approval with the relevant Classification Society, the design and application of the Orkot® Marine Bearings shall take into account the respective rules and regulations of the Society and this manual.

### ■ Management Systems and Classification

Trelleborg Sealing Solutions operate a fully integrated management system which incorporates AS 9100 Quality Management System, ISO 14001 Environmental Management System and ISO 4500 Health and Safety Management System.

Strict quality control and testing ensure material conformance and batch traceability. Routine testing is performed to simulate the extreme operational environments where the materials are used.

Type approval certification is held for Orkot® TLM Marine and TXM Marine grades from the world's leading classification societies. Visit [www.orkotmarine.com](http://www.orkotmarine.com) for copies of the most up to date certificates.

## ■ Properties / Specifications

### ■ Material Datasheet, metric units

Properties	Unit	TLMM	TXMM
Compressive Strength			
Normal to Laminate	N/mm <sup>2</sup>	>300	> 280
Parallel to Laminate	N/mm <sup>2</sup>	>90	>90
Tensile Strength	N/mm <sup>2</sup>	>60	>55
Flexural Strength	N/mm <sup>2</sup>	>65	>65
Elastic Modulus			
Bending	N/mm <sup>2</sup> · 10 <sup>4</sup>	0.19	0.18
Tensile	N/mm <sup>2</sup> · 10 <sup>4</sup>	0.32	0.32
Shear Strength	N/mm <sup>2</sup>	80	80
Impact Strength (ISO 179/1987 Charpy Impact Unnotched)			
Normal to Laminate	KJ/m <sup>2</sup>	120	120
Hardness	Rockwell M	90	90
Density	g/cm <sup>3</sup>	1.3	1.3
Swell in Water (20°C)	% of wall thickness	<0.1	<0.1
Operation Temperature			
for normal use (Without special precautions)	°C	-30 to +65	-30 to +65
Maximum temperature	°C	130	130
Minimum temperature	°C	Cryogenic	Cryogenic
Thermal Expansion Coefficient 20°C - 100°C			
Perpendicular to Laminate	°C · 10 <sup>5</sup>	9 - 10	9 - 10
Parallel to Laminate	°C · 10 <sup>5</sup>	5 - 6	5 - 6
Sliding Properties			
Typical coefficient of friction dry against a corrosion resistant surface such as stainless steel. Bearing pressure 15 N/mm <sup>2</sup>		0.13	0.05 - 0.10

## ■ Material Datasheet, inch units

Properties	Unit	TLMM	TXMM
Compressive Strength			
Normal to Laminate	psi	> 43,500	> 40,600
Parallel to Laminate	psi	> 13,000	> 13,000
Tensile Strength	psi	> 8,700	> 8,000
Flexural Strength	psi	> 9,400	> 9,400
Elastic Modulus			
Bending	psi · 10 <sup>4</sup>	27.6	26.1
Tensile	psi · 10 <sup>4</sup>	46.4	46.4
Shear Strength	lbs/in <sup>2</sup>	11,603	11,603
Impact Strength (ISO 179/1987 Charpy Impact Unnotched)			
Normal to Laminate	ft-lbs/in <sup>2</sup>	57	57
Hardness	Rockwell M	90	90
Density	lbs/in <sup>3</sup>	0.047	0.047
Swell in Water (68°F)	% of wall thickness	<0.1	<0.1
Operation Temperature			
for normal use (Without special precautions)	°F	-22 to +149	-22 to +149
Maximum temperature	°F	266	266
Minimum temperature	°F	Cryogenic	Cryogenic
Thermal Expansion Coefficient 68°F - 212°F			
Perpendicular to Laminate	°F · 10 <sup>5</sup>	5.0 - 5.5	5.0 - 5.5
Parallel to Laminate	°F · 10 <sup>5</sup>	2.7 - 3.3	2.7 - 3.3
Sliding Properties			
Typical coefficient of friction dry against a corrosion resistant surface such as stainless steel. Bearing pressure 2,175 psi		0.13	0.05 - 0.10

## ■ Service and Support

Trelleborg Sealing Solutions have a team of experienced and highly skilled engineers who offer a full and complete service tailored to your specific requirements. Some aspects of this service are:

- Recommendations on adapting our bearings to specific environmental and operational conditions.
- Calculation of bearing dimensions for pre-despatch or on site machining
- Technical assistance with bearing installations
- Full technical backup and support throughout the service life of the bearing
- 24 hour emergency support

This extensive support service is complimented by a comprehensive range of technical documentation and the Orkot® Marine Bearings calculation program.

## ■ WebSite

Visit our website on: [www.orkotmarine.com](http://www.orkotmarine.com) for general and technical information on Orkot® Marine Bearings products and applications. You will be able to view and download certificates, literature and other documents.

## ■ World Wide Availability

Orkot® Marine Bearings distribution network is set up to meet the urgent demands of modern ship repairing. Standard Orkot® TLM Marine tubes, which can be shipped the same day, are stocked world wide by local distributors in the major ship repairing centres. These are backed up by additional large stocks in our manufacturing plants.

Our modern, well equipped facilities can manufacture specific sizes of raw material in both tube and sheet form for despatch within 24 hours. They can also supply a full range of finished-machined products quickly and economically, including:

- Plain bearings
- Flanged bearings
- Grooved bearings
- Staves
- Thrust bearings
- Spherical bearings
- Wear rings
- Pads
- Strips
- Washers

## ■ Marine Stock Tube Sizes

**Table 3: Tube mm (Available in Europe and Asia)**

European Part Number	OD (mm)	ID (mm)	Length (mm)	Weight (kg)	OD (inch)	ID (inch)	Length (inch)	Weight (lbs)
TLM 13	95	47.6	500	3.5	3.7	1.9	19.7	7.7
TLM 21	118	66.7	500	4.9	4.6	2.6	19.7	10.8
TLM 22	150	88.9	500	7.5	5.9	3.5	19.7	16.5
TLM 23A	170	108	500	8.8	6.7	4.3	19.7	19.4
TLM 23	190	120.7	600	12.5	7.5	4.8	23.6	27.6
TLM 24	230	146.1	700	21.9	9.1	5.8	27.6	48.3
TLM 26	305	177.8	780	49.1	12.0	7.0	30.7	108.2
TLM 29	370	235	650	53.3	14.6	9.3	25.6	117.5
TLM 29A	400	270	650	57.8	15.7	10.6	25.6	127.4
TLM 31	445	295	570	64.6	17.5	11.6	22.4	142.4
TLM 32	480	381	590	51.4	18.9	5.0	23.2	113.3
TLM 34	520	403	700	77.2	20.5	15.9	27.6	170.2
TLM 36	595	450	710	110.0	23.4	17.7	28.0	242.5
TLM 39	650	500	800	134.0	25.6	19.7	31.5	295.4
TLM 42	735	600	840	154.0	28.9	23.6	33.1	339.5

**Table 4: Tube inch (Available in the Americas)**

TSS Part Number	ID (inch)	OD (inch)	Length (inch)	Weight (lbs)	ID (mm)	OD (mm)	Length (mm)	Weight (kg)
HTND000600TLMM	0.313	1.000	12	0.40	7.94	25.40	304.80	0.18
HTND000601TLMM	0.375	1.500	12	0.93	9.53	38.10	304.80	0.42
HTND000602TLMM	0.500	2.000	24	3.32	12.70	50.80	609.60	1.51
HTND000603TLMM	0.500	3.000	24	7.75	12.70	76.20	609.60	3.51
HTND000604TLMM	0.750	3.500	24	10.35	19.05	88.90	609.60	4.69
HTND000605TLMM	1.000	4.000	24	13.28	25.40	101.60	609.60	6.02
HTND000606TLMM	1.500	4.500	24	15.94	38.10	114.30	609.60	7.23
HTND000607TLMM	2.000	5.000	24	18.60	50.80	127.00	609.60	8.43
HTND000608TLMM	2.000	6.000	24	28.34	50.80	152.40	609.60	12.85
HTND000609TLMM	2.500	4.500	24	12.40	63.50	114.30	609.60	5.62
HTND000610TLMM	3.000	6.000	24	23.91	76.20	152.40	609.60	10.84
HTND000611TLMM	3.500	7.000	24	32.54	88.90	177.80	609.60	14.76
HTND000612TLMM	5.000	8.000	24	34.53	127.00	203.20	609.60	15.66
HTND000613TLMM	6.000	11.000	24	75.27	152.40	279.40	609.60	34.14
HTND000614TLMM	7.500	12.000	24	77.70	190.50	304.80	609.60	35.24
HTND000615TLMM	9.000	14.000	24	101.83	228.60	355.60	609.60	46.19
HTND000616TLMM	11.000	16.000	24	119.54	279.40	406.40	609.60	54.22
HTND000617TLMM	13.000	18.000	24	137.25	330.20	457.20	609.60	62.26
HTND000618TLMM	15.000	20.000	24	154.96	381.00	508.00	609.60	70.29
HTND000619TLMM	17.000	22.000	24	172.67	431.80	558.80	609.60	78.32
HTND000620TLMM	19.000	24.000	24	190.38	482.60	609.60	609.60	86.35

## ■ Marine Stock Sheet Sizes

**Table 5: Sheet inches (Available in the Americas)**

TSS Part Number	Width (inch)	Length (inch)	Thickness (inch)	Weight (lbs)	Width (mm)	Length (mm)	Thickness (mm)	Weight (kg)
HPND000100TLMM	24	48	0.125	6.77	609.60	1219.20	3.18	3.07
HPND000101TLMM	24	48	0.250	13.54	609.60	1219.20	6.35	6.14
HPND000102TLMM	24	48	0.375	20.30	609.60	1219.20	9.53	9.21
HPND000103TLMM	24	48	0.500	27.07	609.60	1219.20	12.70	12.28
HPND000104TLMM	24	48	0.625	33.84	609.60	1219.20	15.88	15.35
HPND000105TLMM	24	48	0.750	40.61	609.60	1219.20	19.05	18.42
HPND000106TLMM	24	48	0.875	47.38	609.60	1219.20	22.23	21.49
HPND000107TLMM	24	48	1.000	54.14	609.60	1219.20	25.40	24.56

## ■ Standard Production Capacity Guidelines

Trelleborg Sealing Solutions can manufacture parts within the following guidelines. For custom solutions, contact your local Trelleborg Sealing Solutions marketing company.

- Tube products up to 2,250 mm (89 inches) outside diameter and 1,290 mm (51 inches) long
- Sheets products up to 1,200 mm (47 inches) wide and 3,000 mm (118 inches) long



## ■ Rudder Bearings

This section provides general advice on rudder bearing design. It also provides the information required to allow the user to calculate the machining sizes of a rudder bearing before and after fitting.

Alternatively, please feel free to contact Trelleborg Sealing Solutions to provide advice on the machine sizes.

Prior to carrying out any calculation, the following information must be available:

- Minimum bearing operating temperature
- Approximate ambient temperature during machining
- Housing and shaft sizes with tolerances
- Any specific conditions which might affect the operation of the bearing, i.e. misalignment.

## ■ Bearing Design Pressure

Orkot® TLM Marine has global classification approval. Clearly, this is linked to the application and the other components involved. When looking only at the properties of Orkot® Marine bearings much higher loads can be sustained. Orkot® Marine bearings are in use in many other applications such as deck cranes, hatch cover slide pads, mooring systems and ship stabilisers operating at bearing pressures ranging from 25 up to 100 N/mm<sup>2</sup> (3,626 up to 14,504 psi).

## ■ Material Selection

Orkot® TLM Marine is the preferred material grade for rudder stock, pintle, neck and carrier bearings. It incorporates solid lubricants which enable dry running to ensure outstanding wear life for all rudder bushes operating above or below the draft line. The material will operate without lubrication at pressures of 30 N/mm<sup>2</sup> (4,351 psi) for short periods and has been tested at pressures of 14.5 N/mm<sup>2</sup> (2,103 psi) with a velocity of 1.3 m/min (4.3 ft/min) for 1.5 million cycles with minimum lubrication. Orkot® TXM Marine is a high performance material which exhibits lower friction and wear properties than our TLM Marine grade. It is approved to operate without lubrication in rudder bearing applications and has been tested, with lubrication against stainless steel for submarine steering gear at 57 N/mm<sup>2</sup> at 1 m/min (8,267 psi at 3.3 ft/min).

## ■ Lubrication

Water, grease or oil can provide bearing lubrication depending on the application. No axial grooves are required with lubricated rudder bearings. Orkot® TLM Marine rudder bearings are capable of intermittent dry running against K-Monel®, Inconel® 625, Stellite®, duplex stainless and suitable corrosion resistant stainless steels.

## ■ Housing and Shaft Requirements

### HOUSING

The bearing housing internal diameter, particularly on refits, should be measured in at least three positions along its length. At least two measurements should then be taken at 90 degrees to each other in the radial plane and the resultant figures used to obtain the average diameters of each position. If the housing is oval or tapered Orkot® can still be used if the problem is not excessive: 0.1 mm per 100 mm (0.004 inches per 4 inches). The material has some elasticity, but it will not compensate for severe wear. It should be noted that the bearing will take the shape of the housing when fitted with an interference. Edge effects increase local stresses, which shall not exceed 80 N/mm<sup>2</sup>.

The housing should be provided with an adequate chamfer to prevent shaving the bearing when press fitting. Classification guidance notes consider a bearing effectively secured when additional stoppers are arranged to prevent bearings from rotation or axial movement. Retention can be achieved by a shoulder in the housing, keeper plate, keys or threaded fasteners. The following diagram shows a bearing axially retained by a shoulder and keeper plate.

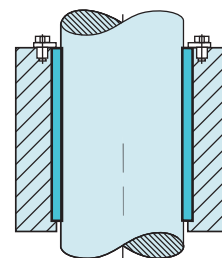

Figure 1: Fitted bearing

### SHAFT

The shaft or liner surface in contact with an Orkot® Marine bearing when running dry or lubricated by water shall be of corrosion resistant material. Suitable materials are seawater corrosion resistant stainless steel, phosphor bronze, gunmetal, Inconel® 625 and Stellite®, ideally with a hardness over 250HV.

The shaft should be smooth, without cutting edges. The ideal shaft surface finish is between 0.1 and 0.8 Ra µm or 4 and 32 Ra micro inches.

## ■ Design

### Wall Thickness

Normally in refits, the wall thickness of the bearing is fixed by the shaft and housing dimensions.

For new bearing designs the optimum wall thickness should be calculated as:

**0.035 x shaft diameter + 2 mm (0.08 inches)**

Any bearing design with a wall thickness below this value should always be checked by our engineering department to ensure it meets our minimum requirements.

It should be noted that when an Orkot® Marine bearing of the optimum thickness is fitted into a housing the interference is reflected as a reduction of the bearings internal diameter after fitting, i.e. the wall thickness before and after fitting will normally remain constant. Bearings with thicker than optimum walls may give less bore closure.

## BEARING INTERFERENCE

Compared with metal equivalents, polymer bearings require greater interference to secure full contact between bearing and housing surfaces at minimum operation temperatures. Full bearing support optimizes the transfer of forces from the shaft to the housing.

Tables 6, 7, 8 and 9 show the various values for “m” and “c” that are required to calculate the recommended interference for Orkot® Marine rudder bearings. These values depend on the minimum operating temperature of the bearing and the temperature of the machine shop at the time of machining.

Once these values have been obtained from the tables they can be entered into the following equation in order to calculate the required interference:

**Interference = (m x Housing ID) + c**

Once an interference value has been calculated it can be entered into the Marine Bearing Calculation. The interference of any bearing design with a wall thickness below our recommendation should be checked by our engineering department.

## BEARING CALCULATION VARIABLES

Table 6

Operating Temp (°C)	Value of “m” Machining Temperature (°C)						
	0	5	10	15	20	25	30
0	0.00131	0.00155	0.00178	0.00202	0.00225	0.00249	0.00273
-10	0.00178	0.00202	0.00225	0.00249	0.00273	0.00296	0.00320
-20	0.00229	0.00253	0.00277	0.00300	0.00324	0.00347	0.00371
-30	0.00291	0.00311	0.00331	0.00351	0.00371	0.00391	0.00411

Table 8

Operating Temp (°F)	Value of “m” Machining Temperature (°F)						
	32	41	50	59	68	77	86
32	0.00131	0.00155	0.00178	0.00202	0.00225	0.00249	0.00273
14	0.00178	0.00202	0.00225	0.00249	0.00273	0.00296	0.00320
-4	0.00229	0.00253	0.00277	0.00300	0.00324	0.00347	0.00371
-22	0.00291	0.00311	0.00331	0.00351	0.00371	0.00391	0.00411

Table 7

Operating Temp (°C)	Value of “c”
0	-0.125
-10	-0.125
-20	-0.143
-30	-0.158

Table 9

Operating Temp (°F)	Value of “c”
32	-0.00492
14	-0.00492
-4	-0.00563
-22	-0.00622

### BEARING CLEARANCE

The minimum recommended bearing clearance for an Orkot® Marine rudder bearing can be established using Figures 2 and 3. The lower line indicates the minimum clearances which we recommend where alignment is good and housing distortion low. The upper line is based on typical classification minimum clearances. For example, Lloyds Register specifies  $0.002d + 1.0\text{mm}$  (0.04 inches) but not less than 1.5 mm (0.06 inches) mm for synthetic bearings. Where Classification Societies, other than Lloyds Register, allow, the mean clearance between the upper and lower lines on the graph can be used. This is based on the Unified requirement UR S10 of IACS OF  $0.001 D + 1 \text{ mm}$  (0.04 inches) minimum clearance but not less than 1.5 mm (0.06 inches) with an additional allowance for water swell and thermal expansion. Our rudder bearing calculation program Issue 8 and later defaults to this clearance. Where the Classification Society rules are not applied, it is suggested that a clearance is selected from between these two lines

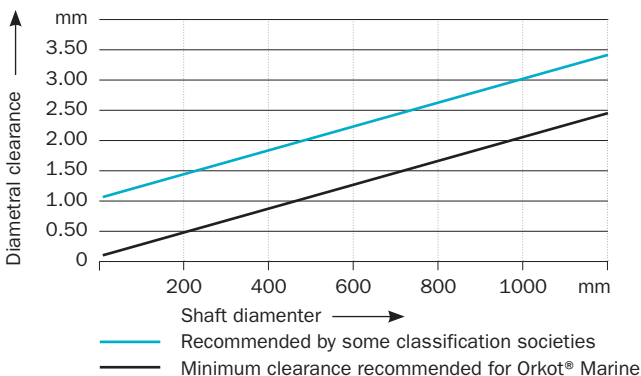

Figure 2: Bearing starting clearance in mm

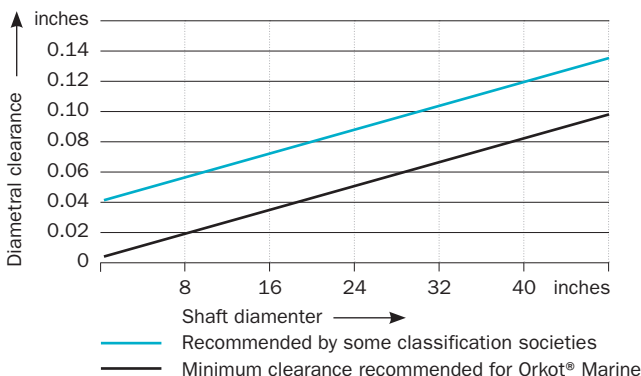

Figure 3: Bearing starting clearance in inches

The equations of the slopes on these graphs are as follows and allow calculation of the clearance figure.

### Metric

- Upper slope (Typical classification minimum):  
Clearance =  $(0.002 \times \text{Shaft Diameter}) + 1.0$
- Lower slope (Orkot® recommended minimum):  
Clearance =  $(0.002 \times \text{Shaft Diameter}) + 0.1$
- Mean between the two slopes (Typically used in Orkot® Marine Bearings calculations):  
Clearance =  $(0.002 \times \text{Shaft Diameter}) + 0.55$

### Inch

- Upper slope (Typical classification minimum):  
Clearance =  $(0.002 \times \text{Shaft Diameter}) + 0.04$
- Lower slope (Orkot® recommended minimum):  
Clearance =  $(0.002 \times \text{Shaft Diameter}) + 0.004$
- Mean between the two slopes (Typically used in Orkot® Marine Bearings calculations):  
Clearance =  $(0.002 \times \text{Shaft Diameter}) + 0.022$

Once a clearance value has been calculated it can be entered into the Marine Bearing Calculation.

### Machining Tolerance

The following tables show the machining tolerances that can be achieved when machining rudder bearings. These can be substituted into the calculation with your own machining tolerance should they differ from those stated.

Once machining tolerance values have been selected they can be entered into the Marine Bearing Calculation to work out the machining dimensions.

### RECOMMENDED MACHINING TOLERANCE OD AND ID FOR ORKOT®

Table 10

Diameter OD and ID mm	Tolerance Band mm
1 - 100	0.10
101 - 300	0.15
301 - 500	0.20
501 - 900	0.25
above 900	0.40

Table 11

Diameter OD and ID inch	Tolerance Band inch
0 - 4	0.004
4 - 12	0.006
12 - 20	0.008
20 - 36	0.010
above 36	0.016

## ■ Water Lubricated Stern Tube Bearings

This section provides general advice on stern tube bearing design. It will also provide the information required to allow the user to calculate stern tube bearing dimensions before and after fitting.

Page 26 contains a blank for you to complete your own calculation.

Prior to carrying out any calculation, the following information must be available:

- Housing and shaft sizes with tolerances
- Approximate ambient temperature during machining
- Any specific conditions which might affect the operation of the bearing, i.e. misalignment.

### ■ Bearing Design Pressure

Water-lubricated propeller shaft bearings need to operate hydrodynamically, i.e the shaft speed should be sufficient to generate a water film to separate the shaft from the bearing. The design of these bearings is governed by the length to shaft diameter ratio which can vary from 4:1 to 2:1 depending on the bearing position and upon approval from the classification societies. Most classification societies apply a ratio of 2:1 for Orkot® Marine grades. Full copies of the certificates are available on our website:

[www.orkotmarine.com](http://www.orkotmarine.com).

### ■ Material Selection

It should be noted that Orkot® materials are not suitable for use in high speed grease or oil lubricated stern shaft systems.

Orkot® TLM Marine is suitable for the majority of water-lubricated stern tube systems.

Orkot® TXM Marine is especially suitable for low shaft velocities i.e. naval surface ship and submarine stern shafts.

### ■ Shaft Requirements

Orkot® Marine bearings can be used with most recognized shaft materials and are found to be compatible with gunmetal, phosphor bronze, Monel, Inconel® 625, 18/8 stainless steel.

If the bearing is subject to abrasive ingress, consideration should be given to the use of harder shaft liners or carbide coatings. Orkot® Marine Bearings tend to improve the surface finish during running. As with all bearings subject to the ingress of abrasive particles, life can be reduced. For the stern tube bearings of a vessel operating under such conditions, a filtered water supply is recommended.

Orkot® TXMM will give a lower wear rate than TLMM in abrasive conditions.

A shaft surface finish below 0.8 µm (32 micro inches) Ra reduces bedding in wear.

### ■ Design

A number of bearing designs can be manufactured from Orkot® Marine grades for stern tube bearing, applications. The types in order of popularity are as follows:

#### MULTI GROOVE BEARING

This conventional bearing design has equi-spaced axial grooves to allow water to circulate and cool the bearing and to enable debris to pass through without causing damage to the shaft or bearing. This design is suitable for most vessels.

#### TWIN GROOVE BEARING

This bearing has two large axial grooves at 90 degrees to the static shaft loading position and allows superior hydrodynamic performance over a wide range of shaft velocities. It was developed from testing Orkot® TLM Marine bearings on a purpose designed shaft testing rig. The design allows for a hydrodynamic film to develop at low shaft velocities reducing friction and wear. Good hydrodynamic performance is obtained with shaft velocities as low as 25 m/min (82 ft/min). This design can also be used for vertical shaft water pumps for marine use.

#### SPECIAL DESIGNS

Special designs for naval applications that incorporate partial arc segmental bearings mounted in split bronze housings are also available.

**STAVES**

An alternative bearing design uses staves machined from Orkot® TLM Marine sheet or tubes. It should be noted that in refits the lignum vitae staves used in some vessels can be easily and more economically replaced with Orkot® TLM Marine multi-groove bearings. After removing the worn staves and keeper strips Orkot® bushes can be machined to suit the bronze carrier in the work shop or alternatively bored in situ.

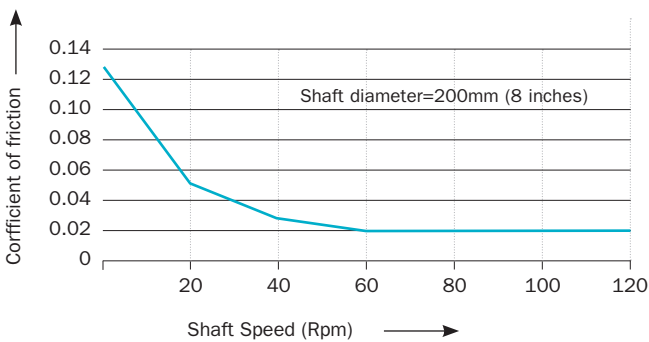

Figure 5: Example of Coefficient of friction as function of shaft speed

**Example:**

Multi and twin groove designs can be manufactured as full or split bearings. Full bearings are normally fitted with an interference fit. This can be achieved by press fitting or freeze fitting. If more than one bearing is required to be fitted into a stern tube, care must be taken to ensure water grooves are in line with each other.

Where multi piece bearings join, a radial groove, similar in size to the bearings longitudinal grooves, should be machined in both bores at the abutment. These grooves ensure that an adequate water flow occurs even if the water grooves in the abutted bearings are not aligned correctly.

Split bearings should be assembled with an interference fit. If necessary this can be achieved using tapered keys.

Orkot® has developed various special split bearing designs for naval applications.

The length to a diameter ratio of an Orkot® Marine grade stern tube bearing should be held to 2:1 if possible. Today the majority of classification societies allow this, as longer bearings increase the problem of alignment. If classification rules require a longer bearing to be used, it is suggested that the bearing clearance at the forward end for the additional length, above the 2:1 shaft to diameter ratio, should be increased to provide a safety bearing. This can reduce the risk of misalignment and is illustrated in figure 6.

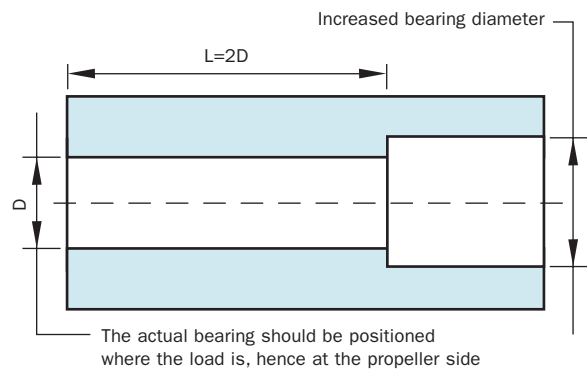

Figure 6: Long bearing with increased clearance “safety bearing”

**WATER FLOW RATE**

A water flow rate of 0.12 liters per minute per mm of shaft diameter is required or 0.8 gallons per minute per inch of shaft diameter.

Bracket bearings, which are fully submerged, do not rely on a forced water supply with controlled flow rate, but draw water directly from its environment.

### ■ Machining Tolerance

The following tables show the standard machining tolerances by Trelleborg Sealing Solutions when machining stern tube bearings. These can be substituted in the calculation with your own machining tolerance should they differ from those stated.

**Warning:** Please note that the Orkot® Marine Bearing calculation is set up as standard to calculate rudder bearing dimensions. As such, the standard machining tolerance figures given must be changed to those stated in this section.

Once machining tolerance values have been selected they can be entered into the Marine Bearing Calculation to work out the machining dimensions.

**Table 14: Recommended Machining Tolerance OD and ID for Orkot® Propeller Shaft Bearings - Metric**

Diameter OD and ID mm	Tolerance Band mm
1 - 100	0.10
101 - 300	0.15
301 - 500	0.20
501 - 900	0.25
above 900	0.40

**Table 15: Recommended Machining Tolerance OD and ID for Orkot® Propeller Shaft Bearings - Inch**

Diameter OD and ID inch	Tolerance Band inch
0 - 4	0.004
4-12	0.006
12-20	0.008
20-36	0.010
above 36	0.016

**Note:**

These tolerances are for guidance only. Reducing them will reduce the maximum clearance after fitting. It is important that the roundness tolerance is maintained when chocking compounds are used.

## ■ Installation

### ■ Fitting Methods

Orkot® Marine Bearings can be fitted using any one of the following methods:

- Freeze fitting
  - Method 1: Using liquid nitrogen (immersion method)
  - Method 2: Using liquid nitrogen (vapor method)
  - Method 3: Using dry ice and alcohol
- Press fitting
- Bonding
- Mechanical fixings

Classification guidance notes consider a bearing effectively secured when additional physical stoppers are arranged to prevent bearings from rotation or axial movement.

#### FREEZE FITTING

This is a fast and efficient assembly method for an Orkot® Marine bearing. The thermal properties of the material allow a good clearance between the bearing and housing when frozen and the material does not become brittle at cryogenic temperatures.

#### Note:

Extreme care should be taken when using liquid nitrogen to avoid severe burns. Adequate ventilation should be provided because oxygen is depleted when gassing occurs in confined spaces. Suppliers of the products will provide a data sheet advising on its use.

#### USING LIQUID NITROGEN (IMMERSION METHOD)

A suggested procedure for method 1 is as follows:

1. Check the outer diameter (OD) of the bearing in at least 3 positions around the top, middle and bottom (a total of 9 measurements) making a note of the largest figure recorded.
2. Check the internal diameter (ID) of the housing in at least 3 positions around the top, middle and bottom (a total of 9 measurements) making a note of the smallest figure recorded.
3. Provide an insulated container capable of withstanding a temperature of -197°C (-320°F) and large enough to accommodate the bearing being fitted with enough clearance on the OD to facilitate the insertion and removal of the bearing.
4. Place the bearing inside the container and make efforts to reduce its internal volume. This can be done by sealing off un-used areas of the container or filling any voids with rough cut timbers. This will reduce the amount of liquid nitrogen that will be required.

5. Cover the bearing with the liquid nitrogen and maintain this level for the duration of the procedure. The nitrogen level will constantly drop as the liquid boils, turns to gas and escapes to the atmosphere. Use an insulated lid to cover the container when possible. Once the liquid stops boiling and settles down to a simmer then the bearing can be lifted slightly from the liquid and the upper OD measured to check for sufficient size reduction. If this has not been achieved then the bearing can be returned to the liquid for 10 to 20 minutes and then checked again.
6. Once sufficient clearance between the bearing and the housing has been achieved, the bearing can be removed from the nitrogen and transported to the housing for fitting.
7. The apparatus used to transport the bearing after freezing will need to be resistant to the cryogenic temperatures they will encounter (e.g. polyester slings) and suitable to support the weights involved.
8. Ensure that the reduced bearing can be located quickly and easily. Once it comes into contact with any conductive surfaces the rate with which it will return to its original dimensions increases greatly.
9. Slide the bearing into position, ensuring that it is held there while its temperature normalizes. Once the bearing's surfaces have cleared of the ice that forms on them during normalization then any supports can be removed.

#### USING LIQUID NITROGEN (VAPOR METHOD)

Orkot® bearings can be fitted without a metal container by vaporizing the liquid nitrogen within the bearing. This uses less liquid nitrogen and is therefore safer and less expensive than the immersion method. Please note however that the rate of bearing contraction is a lot lower using this method when compared to the immersion method. As such the freezing procedure will take a lot longer.

A suggested procedure for method 2 is as follows:

1. Check the outer diameter (OD) of the bearing in at least 3 positions around the top, middle and bottom (a total of 9 measurements) making a note of the largest figure recorded.
2. Check the inner diameter (ID) of the bearing in at least 3 positions around the top, middle and bottom (a total of 9 measurements) making a note of the smallest figure recorded.
3. Prepare a plywood disk with an od half way between that of the OD and the ID of the bearing. Drill a hole of approximately Ø15 - 20 mm (Ø5/8 - 3/4 inches) in the middle of this disk.
4. Place the bearing on a smooth, flat, non-porous surface. Seal the joint between this and the ID of the bearing with silicone sealant.

5. Manufacture a simple lance from 10 mm (3/8 inches) or similar copper tube. Drill approximately twenty 1 mm (3/8inches) diameter holes through both walls of the pipe and fit a bleed valve to the pipe to control the flow of liquid nitrogen. Ensure that you seal the open end of the lance.
6. Place the plywood disk on top of the bearing, and connect the lance to a pressurized liquid nitrogen tank.
7. Turn the valves to control the flow of nitrogen until vapor can be seen escaping under pressure from the lance. If liquid starts to exit the lance then the flow should be reduced until it stops.
8. Place the lance though the hole in the center of the disk and into the bearing. Wrap the bearing in an insulating blanket to reduce energy loss from its surface.
9. During the procedure the nitrogen flow will need to be monitored and adjusted from time to time. Measure the OD at the top of the bearing periodically.
10. Once sufficient clearance between the bearing and the housing has been achieved then the bearing can be transported to the housing for fitting.
11. The apparatus used to transport the bearing after freezing will need to be resistant to the cryogenic temperatures they will encounter (e.g. polyester slings) and suitable to support the weights involved.
12. Ensure that the reduced bearing can be located quickly and easily. Once it comes into contact with any conductive surfaces the rate with which it will return to its original dimensions increases greatly.
13. Slide the bearing into position, ensuring that it is held there while its temperature normalizes. Once the bearing's surfaces have cleared of the ice that forms on them during normalization then any supports can be removed.

**USING DRY ICE AND ALCOHOL**

Freeze fitting using dry ice and alcohol will only provide the required clearance when using very light interferences. As such, it is rarely a viable method in its own right and will often also require press fitting.

**FITTING WITH HYDRAULIC PRESS OR CENTER PULL JACKS**

If a bearing is to be press fitted, installers should ensure that they have equipment available to deliver adequate force to press the bearing fully into the housing. The ease of fitting will vary dependent on the finish of the housing. This should be considered when calculating the force required. When press fitting a bearing, it is important that it is in line and square with the bore before the operation begins. An adequate chamfer on the housing will prevent shaving of the bush. The diagram (Figure 8) illustrates a method of ensuring the bush is square before the fitting starts.

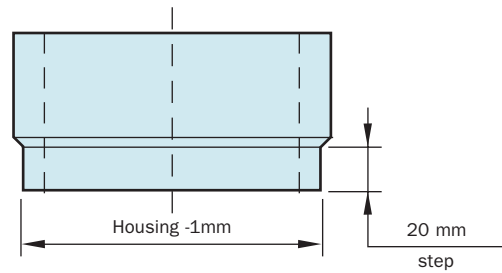

Figure 8: Method of ensuring the bush is square before the fitting starts.

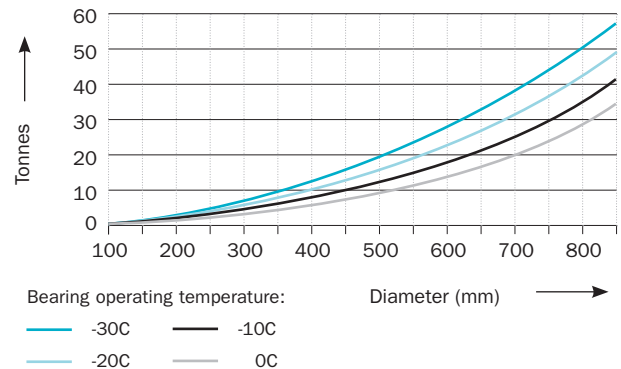

Figure 9: Fitting force (Metric tonnes)

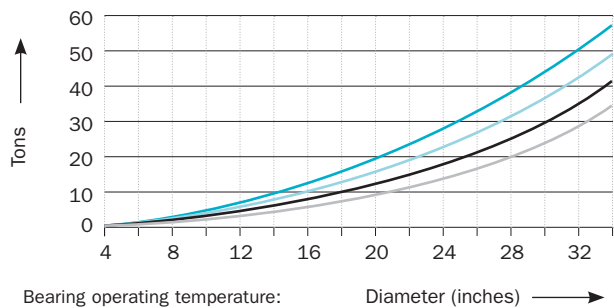

Figure 10: Fitting force (Tons)

Figures 9 and 10 show the typical fitting force of a bearing, length/diameter ratio 1.

An initial force to move the bearing may be higher than given in the graph.

The actual force will vary dependent on the condition of the housing, leading chamfers and the length versus diameter ratio.



## BONDING

The method of fixture will depend upon the design employed. However, the key point to be emphasized here is that in addition to traditional mechanical fixing, Orkot® materials can be bonded to both itself and metallic substrates. Please note that if the assembly is to experience in excess of +60°C to +70°C (+140°F to +158°F) then interference fitting should be replaced with adhesive bonding.

Numerous adhesives are compatible with Orkot® and have been tested within our laboratory facilities.

Generally the most suitable adhesives are:

- Epoxies
- Acrylics
- Cyanoacrylates
- Polyurethanes

The following is a list of adhesive suppliers whose products have been tested and are approved for use with Orkot® materials:

- Araldite®
- Belzona®
- Chockfast®
- Loctite®

For specific details of bonding agents and conditions please contact our technical department or your local adhesives specialist.

General terms and preparations are required irrespective of the adhesive to be used.

### Preparations:

- Suitable substrates are Orkot® materials themselves and various metals (including Stainless Steel).
- Plastics such as polyethylene, polypropylene, polycarbonate, PVC, PTFE are unsuitable substrates for bonding to Orkot® materials.
- The key to effective adhesion is in the preparation of the substrate and the material to be bonded.
- Ensure no boundary layers such as oxides or grease are present. Degrease with a suitable solvent ensuring local health and safety guidelines are followed. Orkot® can be degreased by using a quick wipe with a solvent such as acetone, but exposure to the solvent must be kept brief so as not to attack the Orkot® material. Oxides can be removed by use of fine abrasive paper or wire wool.
- Roughen the surface. Ideally where metals are involved use shot blasting. Ensure any remaining particulates are

removed from the surface. Generally the slightly fibrous surface of Orkot® does not require roughening, though the use of abrasive paper is acceptable so long as any dust is removed.

- The assembled components may need support while the adhesive sets. This cure time will vary with the conditions under which the adhesive is used. Typically a rule of thumb is that the cure time will be halved for every +10°C/+50°F increase in temperature.
- In terms of assembly, avoid butt joints in favor of lap, so that loads applied to the adhesive joint will act across the assembly in shear.

## MECHANICAL FIXING:

Orkot® bearings can be securely retained axially using mechanical stoppers such as shoulders and keeper plates. Alternatively threaded fasteners can be used to fix the bearing or bearing segments to the housing. When using stoppers, ensure a tight fitting of the bearing in the housing, which can be achieved by an interference fit. Rotational movement can be restricted by keys or threaded fasteners.

When fitting Orkot® with threaded fasteners to the housing, the fasteners should be chemically or mechanically locked to avoid loosening during operation. Generally, fasteners shall be hand tightened to obtain a snug fit. The heads of the fasteners must be sunk below the bearing surface to avoid fouling with the counter surface (i.e. shaft).

## Machining Instructions

### GENERAL

Orkot® materials are readily machinable by conventional machine shop techniques. As a general guide, methods used for brass, aluminium or lignum vitae will apply for Orkot® materials. It is preferable to use tungsten carbide turning tools with cutting speeds of 5.5 m/s (19 ft/s). Orkot® materials must be machined dry without the use of coolant.

### TURNING

Tungsten carbide tooling of the butt welded type using K20 grade carbide is suitable for most applications. If carbide inserts are used, then aluminium grades with high positive rates give best results (e.g. Plansee grade H10T, Sandvik H10A or H13A, Mitsubishi HT110.)

For heavy wall thickness, the internal and external diameters should be machined together to reduce vibration.

No asbestos is used in the manufacturing of Orkot® Marine and the material is non-toxic. It is however advisable to use adequate dust extraction when machining. If unavailable, operators should wear dust particle masks.

For small volume work and machining of chamfers, radii and other forms, then high speed steel gives good results, but tool life is shorter than with tungsten carbide.

### Cutting Angle for Tools

#### Turning

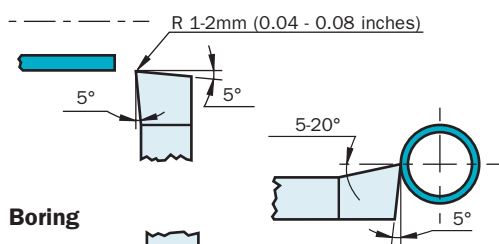

#### Boring

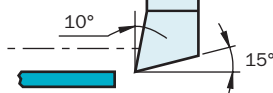

#### Parting off

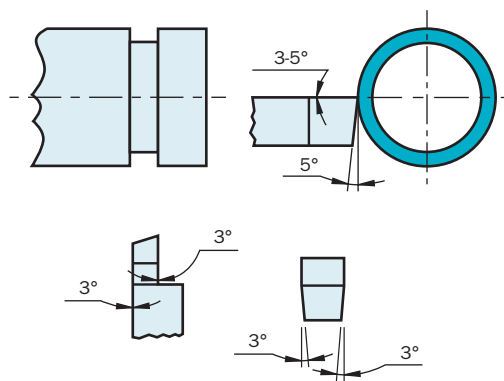

Table 16: Speeds - Metric Machining

Diameter (mm)	Rpm
0 - 50	2100
50 - 100	1000
100 - 150	700
150 - 200	550
200 - 300	350
300 - 400	250
400 - 500	200
500 - 600	175
600 - 700	150
700 - 800	130
800 - 900	120
900 - 1000	100

Table 17: Speeds - Inch Machining

Diameter (inch)	Rpm
0 - 2	2100
2 - 4	1000
4 - 6	700
6 - 8	550
8 - 12	350
12 - 16	250
16 - 20	200
20 - 24	175
24 - 28	150
28 - 32	130
32 - 36	120
36 - 40	100

**Table 18: Feeds - Metric**

Type of machining	Roughing	Finishing	Unit
Turning	0.7	0.25	mm/rev
Boring	0.5	0.20	mm/rev
Parting	0.4	0.20	mm/rev

**Table 19: Feeds - Inch**

Type of machining	Roughing	Finishing	Unit
Turning	0.028	0.010	inch/rev
Boring	0.020	0.008	inch/rev
Parting	0.016	0.008	inch/rev

**GROOVING**

Orkot® materials can be readily grooved on a lathe, shaping, milling or boring machine with a 90° machining head. For most one off applications a lathe is adequate. A sharp high speed steel tool ground to the correct form should be clamped in a long boring bar with a three degree clearance ground on the side of the tool. No top clearance is required. A 0.2 mm (0.008 inches) depth of cut should be used. For long bearings a steady may be required. The machine fast traverse, (with the spindle locked) can often be used. Linear speeds up to 10 m/min (30 ft/min) can be achieved.

**Table 20: Speeds and Feeds by Drilling - Metric**

Drill Diameter mm	Speed Rpm	Feed mm/min
5	1600	300
10	800	400
15	600	400
20	400	400
25	350	400
30	300	400

**Table 21: Speeds and Feeds by Drilling - Inch**

Drill Diameter inch	Speed Rpm	Feed inch/min
0.2	1600	12
0.4	800	16
0.6	600	16
0.8	400	16
1.0	350	16
1.2	300	16

**DEPTH OF CUT**

Roughing 10 mm (0.4 inches)  
 Finishing 3 mm (0.12 inches)

Smaller cuts may lead to tools rubbing, causing wear which produces excessive heat build up in the finished part.

## ■ Health and Safety Data

### 1. PRODUCT AND COMPANY IDENTIFICATION

Product name:	Orkot®	
Suppliers:	Trelleborg Sealing Solutions Rotherham Bradmarsh Business Park Rotherham S60 1BX United Kingdom	Trelleborg Sealing Solutions Streamwood 901 Phoenix Lake Ave. Steamwood, IL 60107 USA
Emergency telephone number:	+44 1709 789 840	+1 630 289 1500

### 2. COMPOSITION / INFORMATION OF INGREDIENTS

General Description:	Fiber reinforced plastic material
Information on ingredients:	May contain – Polyester/aramid fibers, polyester/epoxy resin, PTFE, molybdenum disulfide, graphite, calcium carbonate

### 3. HAZARDS IDENTIFICATION

Physical/chemical hazards:	None known
Human health hazards:	None known, avoid breathing machining dust

### 4. FIRST-AID MEASURES

Inhalation:	Fresh air, seek medical advice if irritation develops
Ingestion:	Wash out mouth with water, seek medical advice
Skin contact:	Not applicable
Eye contact:	Irrigate with appropriate eye wash

## 5. FIRE-FIGHTING MEASURES

Suitable extinguishing media:	Water, foam, carbon dioxide, dry powder
Not suitable extinguishing media:	Not applicable
Hazardous decomposition products:	Carbon, carbon oxides
Protection of fire fighters:	Use breathing apparatus

## 6. ACCIDENTAL RELEASE MEASURES

Personal precautions:	Filter mask for dust (machining)
Environmental precautions:	Avoid dispersion of dust (machining)
Methods for cleaning up:	Transfer into suitable containers for disposal

## 7. HANDLING AND STORAGE

Handling:	Observe good industrial safety and hygiene practice.
Storage:	Store in a cool, dry place out of direct sunlight
Recommended packaging:	Paper, card, plastics, wood

## 8. EXPOSURE CONTROLS / PERSONAL PROTECTION

Engineering measures:	When machining use local exhaust ventilation. Collect dust for disposal Machined swarf is flammable
Hygiene measures:	Avoid breathing machined dust.
Occupational exposure limits	
Chemical name:	Dust
Regulations:	Check relevant local regulations
Personal protective equipment	
Respiratory system:	Dust mask, type FFP1 minimum
Skin and body:	Work clothing
Hands:	Not applicable
Eyes:	Safety goggles when machining
Other protective equipment:	Not applicable

## 9. PHYSICAL AND CHEMICAL PROPERTIES

Physical state:	Solid
Color:	Variable – white, black, gray, blue, turquoise, green (compound dependent)
Odor:	Weak, characteristic
Melting point:	Does not melt
Bulk density:	1200 – 1450 kg/m <sup>3</sup>
Solubility in water:	Insoluble
pH :	Not applicable
Flash point:	Not applicable
Explosion properties:	As with all dusts a risk of explosion exists in restricted environments

## 10. STABILITY AND REACTIVITY

Stability:	Stable
Conditions to avoid:	If Orkot® TXM Marine is burned with flame or laser engraved, toxic fumes are emitted, thus appropriate ventilation should be provided.
Materials to avoid:	If Orkot® TXM Marine is burned with flame or laser engraved, toxic fumes are emitted, thus appropriate ventilation should be provided.
Hazardous reactions:	None known
Hazardous decomposition products:	Decomposition does not occur under recommended storage and handling

## 11. TOXICOLOGICAL INFORMATION

Inhalation:	Inhalation of dust may cause irritation to respiratory tract
Acute toxicity – Oral:	None known
Skin irritation:	None known
Eye irritation:	Dust may cause irritation
Other information:	No known toxicological effects are associated with this material

## 12. ECOLOGICAL INFORMATION

Persistence/degradability:	This material is not readily biodegradable
Ecotoxicity:	No known ecotoxicity exists
Other information:	Not applicable

**13. DISPOSAL CONSIDERATION**

Waste of residues:	Disposal in accordance with national and local regulations
Contaminated packaging:	Packaging can be recycled Cleaning agent - water Cleaning agent - water

**14. TRANSPORT INFORMATION**

National transport regulations (UK):	Not applicable
--------------------------------------	----------------

**15. REGULATORY INFORMATION**

Classification according to EU: Regulations 67/548/EEC-88/379/EEC	This product does not have to be classified
--	---

Safety phrases:	Avoid breathing machining dust
-----------------	--------------------------------

Contains:	Not applicable
-----------	----------------

National regulations United Kingdom:	No additional national regulations are known to the supplier
---	--

**16. OTHER INFORMATION**

This safety data sheet is based on Trelleborg Sealing Solutions present knowledge and experience, and is intended to serve as a guide for safe handling of the product regarding to health and environmental aspects.

The information given in this data sheet was obtained from sources we believe are reliable. The information is, however, provided without any representation or warranty, expressed or implied, regarding its accuracy or correctness.

The conditions or methods of handling, storage, use and disposal of the product are beyond our control and may be beyond our knowledge. For this, and other reasons, we do not assume responsibility and expressly disclaim liability for loss, damage or expense arising out of or in any way connected with the handling, storage, use or disposal of the product.

## Rudder/Stern Shaft Bearing Machining Dimensions Calculation

Company:		Date:	
Contact:		Phone:	
Vessel Name:		Fax:	

Company:		Application:	
----------	--	--------------	--

All measurements are in mm unless otherwise stated.

Housing I/D Max (mm)		Shaft O/D Max (mm)	
Housing I/D Min (mm)		Housing I/D Min (mm) Shaft O/D Min (mm)	
Operating Temp (Degrees C)		Machining Temp (Degrees C)	
		Clearance Recommended by Some Classification Societies	
		Min Clearance Recommended by Orkot Ltd	
Min Interference (mm)		Min Clearance (mm) (Mean of Above)	
<b>Manual Override</b>		<b>Manual Override</b>	
M/C Tolerance (O/D) (mm)*		M/C Tolerance (I/D) (mm)*	
<b>Manual Override</b>		<b>Manual Override</b>	

(A) Housing I/D Max + Interference Min	=	Bearing O/D Min (A)
+	=	
(B) Bearing O/D Min (A) + M/C Tolerance (O/D)	=	Bearing O/D Max (B)
+	=	
(C) Shaft O/D Max + [Bearing O/D Max (B) - Housing I/D Min] + Min Clearance	=	Bearing I/D Min (C)
+ [ - ] +	=	
(D) Bearing I/D Min (C) + M/C Tolerance (I/D)	=	Bearing I/D Max (D)
+ [ - ] +	=	
(E) Bearing I/D Min (C) - [Bearing O/D Max (B) - Housing I/D Min]	=	Bearing I/D Fitted Min (E)
- [ - ]	=	
(F) Bearing I/D Max (D) - [Bearing O/D Min (A) - Housing I/D Max]	=	Bearing I/D Fitted Max (F)
- [ - ]	=	
(G) Fitted Bush I/D Min (E) - Shaft O/D Max	=	Fitted Clearance Min (G)
-	=	
(H) Fitted Bush Max (F) - Shaft O/D Min	=	Fitted Clearance Max (H)
-	=	

\* These figures apply to Orkot® machining processes. If your process tolerances are different then override them in the box provided

This calculation is based on many decades of experience in the manufacture and application of bearing systems. Unknown parameters and conditions may affect individual applications. It is vital that customers satisfy themselves as to the suitability of individual solutions as well as compliance with applicable guidance or rules.



**For further information please contact:**

Trelleborg Sealing Solutions Rotherham	Telephone
Bradmarsh Business Park Rotherham S60 1BX United Kingdom 24 Hour Emergency Line: E-Mail:	+44 (0)1709 789 829  +44 7802 463 928 enquiries@orkotmarine.com
Trelleborg Sealing Solutions Streamwood	Telephone
901 Phoenix Lake Avenue Streamwood, IL 60107 USA E-Mail:	+1 (630) 289 1500  enquiries@orkotmarine.com

Trelleborg is a world leader in engineered polymer solutions that seal, damp and protect critical applications in demanding environments. Its innovative solutions accelerate performance for customers in a sustainable way.

Trelleborg Sealing Solutions is a leading developer, manufacturer and supplier of precision seals, bearings and custom-molded polymer components. It focuses on meeting the most demanding needs of aerospace, automotive and general industrial customers with innovative solutions.

[WWW.TSS.TRELLEBORG.COM](http://WWW.TSS.TRELLEBORG.COM)



[facebook.com/TrelleborgSealingSolutions](https://facebook.com/TrelleborgSealingSolutions)  
[twitter.com/TrelleborgSeals](https://twitter.com/TrelleborgSeals)  
[youtube.com/TrelleborgSeals](https://youtube.com/TrelleborgSeals)  
[linkedin.com/company/trelleborg-sealing-solutions](https://linkedin.com/company/trelleborg-sealing-solutions)

Trelleborg Sealings Solutions Rotherham, Bradmarsh Business Park, Rotherham S60 1BX United Kingdom  
Tel: +44 (0)1709 789 829, 24 Hour Emergency Line: +44 7802 463 928, Email: [enquiries@orkotmarine.com](mailto:enquiries@orkotmarine.com)

Trelleborg Sealings Solutions Streamwood, 901 Phoenix Lake Avenue, Streamwood, IL 60107 USA  
Tel: +1 (630) 289 1500, Email: [enquiries@orkotmarine.com](mailto:enquiries@orkotmarine.com)

If you'd like to talk to Trelleborg Sealing Solutions, find your local contact at: [www.orkot.com](http://www.orkot.com)